

10 in 1 Service Interval and Airbag Reset



OPERATION MANUAL

CONTENTS

	Page
1. Safety Precautions	3
2. Introductions	4
3. Controls and Indications	4
4. Car Coverage and Function	5
5. Operations	8
6. Other LCD display	12
7. Data Link Connector (DLC) Location	17
8. Disclaimer	24
9. Limited Warranty	25
10. Limitations of Warranty	26

1.0 SAFETY PRECAUTIONS:



Engines produce carbon monoxide gas which is odorless, has a slower reaction time and this can lead to serious injury or even death. When the engine is operating, keep the service areas **WELL VENTILATED** or attach the vehicle exhaust outlet to the shop exhaust removal system.



Set the parking brake and chock the wheels before testing or repairing the vehicle. It is especially important to chock the wheels on front-wheel drive vehicles as their parking brakes do not sufficiently hold wheels.



When disconnecting the Service Light Reset Tool from the vehicle, ensure the ignition is switched "OFF" first.



If power is needed to connect to the battery posts, make sure the RED clip is to the positive (+) side and the BLACK clip is to the negative (-) side. **NEVER REVERSE THE POLARITY.**

This unit is an electronic device, never hit or drop it while in use.

When attaching the connector to the vehicle Data Link Connector (DLC), do not use excessive force. Connect it firmly.

Different vehicle makes have different ways of supplying power to the unit. Some diagnostic connectors are self-powered and some are not.

2.0 INTRODUCTION:

This **Master Service Interval Reset Tool** is an up-to-date mechanic's tool for resetting of oil service light, service warning light, service mileage, service intervals and airbag on European made vehicles: AUDI, BMW, CITROEN, MERCEDES BENZ, MINI, SAAB, SEAT, SKODA, VOLKSWAGEN, VOLVO, etc. It is light, compact and very convenient without using the OEM Scanner to do the job. Once hooked up to the vehicle Data Link Connector (DLC), it can perform the following functions:

- Ø Reset of Oil Service Light
- Ø Reset of Service Warning Light
- Ø Setting of Oil Service Mileage
- Ø Setting of Service Mileage Interval
- Ø Setting of 1st Inspection Service Interval
- Ø Setting of 2nd Inspection Service Interval
- Ø Distinguish of Airbag Warning Light.

3.0 CONTROLS AND INDICATORS:



1. **LCD screen**
Display of text during operation.
2. **p Key**
This key is to scroll up the page.
3. **OK Key**
This key is to confirm the selected function and will enter when pressed.
4. **q Key**
This key is to scroll down page.
5. **ESC Key**
When this key is pressed, it will exit and return to the previous function.
6. **Snap on** connector for quick connection.
7. **OBDII connector** for Mercedes Benz.

4.0 Car Coverage (up to year 2005) and Function:

AUDI (1991 Above)

Model	Function
A3 A4 A6 A8 A100	<ul style="list-style-type: none"> • Reset Oil Inspection Light • Set Inspection 1 Service Interval • Set Inspection 2 Service Interval • Reset Airbag
TT	<ul style="list-style-type: none"> • Reset Oil Service Light • Reset Airbag
Other Models	<ul style="list-style-type: none"> • Auto Detect

BMW (1998 Above)

Model	Function
3 Series E36 7 Series E38 5 Series E39	<ul style="list-style-type: none">• Reset Oil Service Light• Set Inspection Mileage
3 Series E46 (OBDII)	<ul style="list-style-type: none">• Reset Oil Inspection Light• Set Inspection 1 Service Interval• Set Inspection 2 Service Interval• Reset Airbag
Other Models Type 1 Type 2	<ul style="list-style-type: none">• Reset Oil Service Light• Set Inspection Mileage

CITROEN

Model	Function
Saxo Xantia Xsara	<ul style="list-style-type: none">• Reset Airbag

MERCEDES BENZ (1996 Above)

Model	Function
A Class C Class E Class CLK Class	<ul style="list-style-type: none">• Reset Oil Service Light• Reset Airbag
E Class > 99 E Class (OBDII) M Class S Class	<ul style="list-style-type: none">• Reset Airbag
Other Models	<ul style="list-style-type: none">• Reset Oil Service Light

MINI

Model	Function
Mini	<ul style="list-style-type: none">• Reset Airbag

SAAB

Model	Function
Saab 900	<ul style="list-style-type: none">• Reset Airbag

SEAT

Model	Function
Alhambra Alhambra >98	<ul style="list-style-type: none">• Reset Oil Inspection Light• Set Inspection 1 Service Interval• Set Inspection 2 Service Interval• Reset Airbag
Arosa Leon Toledo	<ul style="list-style-type: none">• Reset Oil Service Light• Reset Airbag

SKODA

Model	Function
Fabia Octavia Octavia >98	<ul style="list-style-type: none">• Reset Oil Inspection Light• Set Inspection 1 Service Interval• Set Inspection 2 Service interval• Reset Airbag

VOLKSWAGEN (1991 Above)

Model	Function
Golf 3, Golf 4 New Beetle Passat B5, Passat >97 Polo >98 Sharan Lupo	<ul style="list-style-type: none">• Reset Oil Inspection Light• Set Inspection 1 Service Interval• Set Inspection 2 Service Interval• Reset Airbag
Sharan >98	<ul style="list-style-type: none">• Rest Oil Inspection Light• Set Inspection 1 Service Interval• Set Inspection 2 Service Interval
Other Models	<ul style="list-style-type: none">• Auto Detect

VOLVO (1992 Above)

Model	Function
V 40 V 70 850 850 TDI	<ul style="list-style-type: none">• Reset Oil Service Light• Reset Airbag
Other Models Type 1 Type 2	<ul style="list-style-type: none">• A/B Connector (Auto Detect)• OBD2 Connector (Auto Detect)

5.0 OPERATION

This Service Light and Airbag Reset tool is powered up directly through the vehicle Data Link Connector (DLC) except Volvo (A/B connectors) which needed an external 12V DC source.

Once connected to the vehicle DLC and the ignition switched to "ON" position, the LCD screen will display:



ê Will change after a few seconds to:



Select the vehicle you need to work with by pressing the scroll up **p** button or scroll down **q** button to select the vehicle Manufacturer. The asterisk appears next to the number is an indication that it will be selected when **OK** button is pressed.

For example:

If the vehicle you wish to select is **BMW**, model **E46 – OBD2** Pressing **q** button until the display shown with an asterisk next to its name as shown:



Then press **OK** button, the display will show:



Press **q** button until the asterisk display at **E46 – OBD2** as shown below:

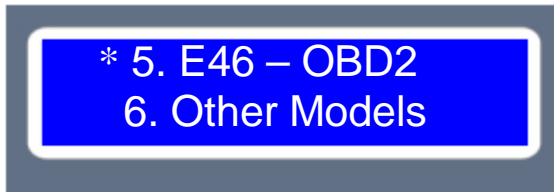

Pressing **OK** button will change the display to:



Then press **q** button again to select the displayed item you want and confirmed with **OK** button.



Once confirmed with **OK** button, the RESET Tool will communicate with the vehicle ECU automatically as shown below:



If the communication gets through, the unit will perform reset function automatically. The display will show as below if it had succeeded.



If the communication or the RESET function failed, the display will show as below.



Then you need to check the cable and the connector for good contact and also whether the ignition switch is turned "ON". After checking and the problem rectified, press **ESC** button to exit and perform RESET function again.

6. OTHER LCD SCREEN DISPLAYS:

Depending on the vehicle Manufacturer and model, the resetting procedures will be guided by the LCD displays. The explanations of the displays are as follows:



This display will show if the vehicle Manufacturer you have selected has “Other Models” in its menu and it will display when the particular car model you have selected failed to perform RESET. This message will prompt you when you press **ECS** button to exit.

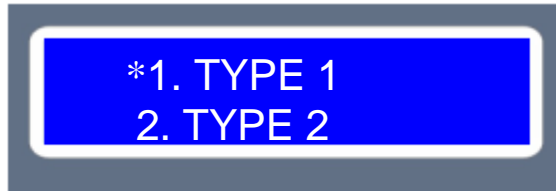

The above display will show when “**Other Models**” has been selected to perform resetting procedures in **BMW** and **Volvo** menus. This menu (**TYPE 1 / TYPE 2**) is used on car models not listed in the car model menu.

Select **TYPE 1** to perform the RESET procedure first failing which then only select **TYPE 2**.

For **BMW** and **VOLVO**, always observe the Oil Service Light or Service Inspection Light when the resetting operation finishes and the display shows “**RESET OK!**”

The warning light on the instrument panel should goes OFF and the Service mileage (KM) will be set automatically if succeeded.

If the Oil Service Light or Service Inspection Light failed to go OFF or reset even though display shown “RESET OK!”, then in this case change to the next selection (**TYPE 2**) and perform the RESET procedure again to clear and reset the warning light.

The reason for failure to clear the warning light or reset the service mileage at the first instant is that the Reset Tool did not get the

feedback from the ECU whether the operation is successful or not. It just sent instructions to the ECU to reset and once finished the display will display “**RESET OK!**” without acknowledgement from ECU. Therefore the selection of **TYPE 1** and **TYPE 2** are used in case the reset of warning light and the service mileage do not response as both (TYPE 1 and TYPE 2) send different instructions.

For **AUDI, VOLKSWAGEN** vehicles, once the communication has established the display will show as below:

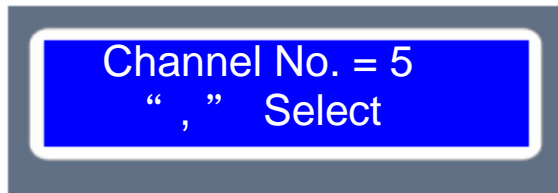

The channel number selection is meant for selecting type of reset operation you want as given from the chart below:

AUDI

Model	Channel Nr.	Reset Description
A4 > 94	5	Oil Service: 15000 KM
A6 / C4 > 98	6	INSP - KM Service: 30000KM
	7	INSP1- Time Service:360 days
	8	INSP2- Time Service: 720 days
	15	Oil Service: 15000 KM
A6/C5 > 97	6	INSP-KM Service: 30000KM
A8	7	INSP-Time Service: 360 days

VOLKSWAGEN

Model	Channel Nr.	Reset Description
Passat (B5) > 97	11	INSP-KM Service: 30000KM
Polo > 97	10	Oil Service: 15000KM

Press **p** or **q** button to increase or decrease the channel number and then press **OK** button to confirm.

Operation Example:

Once **channel 5** has been selected and confirmed, the screen displays as follow:



Press **OK** button again will change the display to:



To input the next oil service mileage, press **p** or **q** button, the screen will display the set mileage and confirm with **OK** button. The next screen display as follows:



After awhile, the screen displays:



7.0 DATA LINK CONNECTOR (DLC) LOCATION:

VOLVO

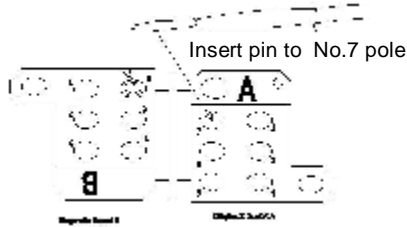

A/B Connector

This DLC is located at the left side of the engine compartment, beside the absorber mounting. To connect the VOLVO adapter, insert the banana plug into the No.7 pole of the DLC socket A.

Then clip the RED crocodile clip to the battery positive (+) terminal and the BLACK crocodile clip to the battery negative (-) terminal. **NEVER REVERSE THE POLARITY.**

AUDI, VOLKSWAGEN



DLC located between front seats near parking brake under rubber cover.

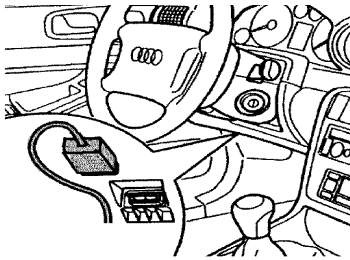

DLC located under dash.

DLC under Dash Board

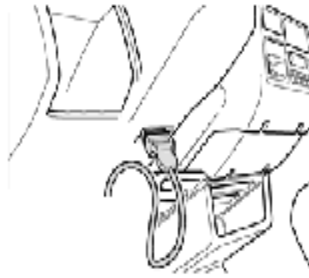

DLC located under steering column.

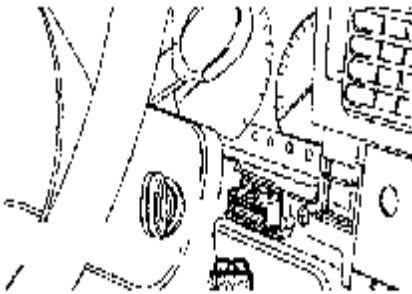

DLC connector is located in the rear of the rear seat column.

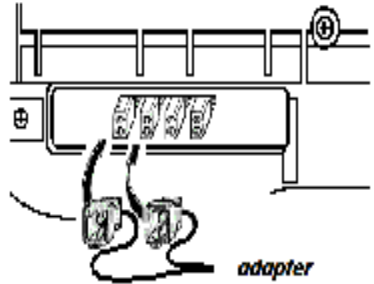

DLC located near center console in front of seat.

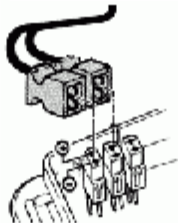

DLC located in fuse box under hood near firewall.

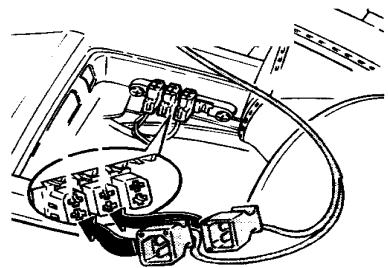

DLC located under the shiftboot in the center console.

BMW



20 Pins DLC located at the Engine compartment



16 Pins (OBDII) DLC under dashboard beside the steering

MERCEDES BENZ

1. Engine Control Module (HEM-SF)
2. Relay Module
3. Data Link Connector (DTC Readout)

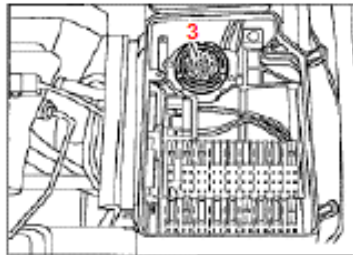
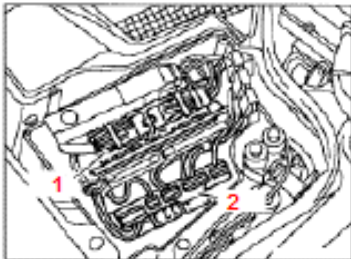

E320

8. OBDII (16 Pins) DLC Location Mappings:

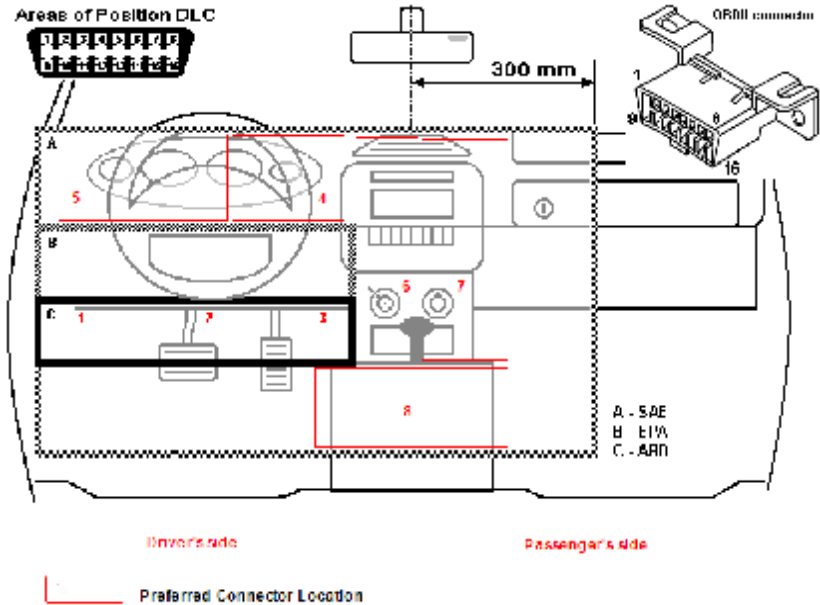

Explanation of Diagram Numbered Locations

Location #	Description
1	Driver's side, underneath dashboard, in the area under the steering column, +/- 150 mm (i.e., +/- 6 inches on either side of the steering column)
2	Driver's side, underneath dashboard, between the driver-side door and steering column area
3	Driver's side, underneath dashboard, between the steering column area and the center console (also includes connectors on the driver side but connected to the center console)
4	Driver's side, dashboard instrument/gauge area, between the steering column and center console
5	Driver's side, dashboard instrument/gauge area, between the driver-side door and steering column
6	Center console, vertical surface (i.e., near radio and climate controls), left of vehicle centerline
6/7	Center console, vertical surface (i.e., near radio and climate controls), on vehicle centerline
7	Center console, vertical surface right of vehicle centerline or on passenger side of center console
8	Center console, horizontal surface (i.e., armrest, handbrake area), in front passenger area
9	Any location other than locations # 1-8 (i.e., rear passenger area, passenger side glove box, top of dashboard near windshield)

***Note:**

- Locations #1-3 represent preferable locations, Locations #4-8 represent allowable locations under SAE J1962
- Connectors in location # 6, #6/7, and #7 may be covered by ashtrays, covers, cup holders, coin holders, etc.

Diagnostic Link Connector (DLC) Diagram

Cover Types

Some manufacturers use covers to protect the integrity of the connector pins and/or to prevent impact with vehicle passengers in an accident. The following diagrams provide an example of some of the covers that manufacturers have used. This does not include ashtrays, coin holders, cup holders, the dashboard itself, or other similar items used to conceal the connector.

Protective Cover

- small, soft-plastic cover used to enclose DLC pins; may or may not have embossed "OBD" or "OBD II"



Flip Cover

small, hinged hard plastic cover; typically has an indentation or tab to help 'flip' it open

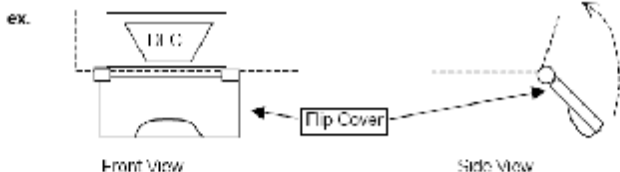

Fuse Panel or Panel Cover

Large, hard plastic cover that is color keyed to the dashboard; may or may not have embossed "OBD" or "OBD II," or a label

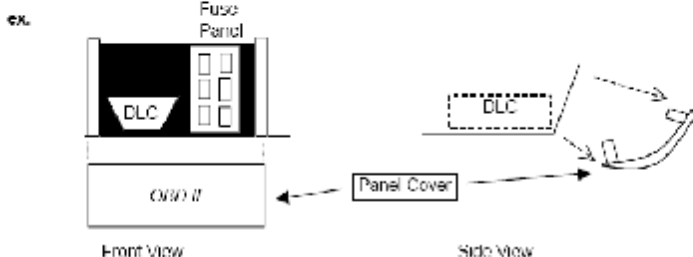

AUDI

Model	Year	Connector Location	Remarks
A4 A8 TT S4	96 ~ 00	2 - open	
A6 Cabriolet	96,97	9 - cover	Behind ashtray
A3 A8 (EU)	2000 ~	8 - cover	Behind ashtray
A4 (EU)	2000 ~	9 - cover	Behind ashtray
A6 (EU)	2000 ~	2 - open	

BMW

Model	Year	Connector Location	Remarks
3 Series 5 Series 8 Series X5 Series	96 ~ 00	2 - cover	
7 Series	96 ~ 00	6 - cover	Near radio
Z3 Series	96 ~ 00	7 - cover	Under dash

MERCEDES BENZ

Model	Year	Connector Location	Remarks
Most models	96 ~ 00	2 - cover	
Some models	2000 ~	1 - open	

SAAB

Model	Year	Connector Location	Remarks
Saab 900 Saab 9000 Saab 9-3	96 ~ 00	1 - cover	
Saab 9-5	99 ~ 00	3 - cover	

SEAT

Model	Year	Connector Location	Remarks
Alhambra	98 ~	7 - cover	
Arosa	99 ~	6 - cover	
Leon Toledo	99 ~	1 - cover	

SKODA

Model	Year	Connector Location	Remarks
Fabia	98 ~	6 - cover	
Octavia	98 ~	1 - cover	

VOLVO

Model	Year	Connector Location	Remarks
S40 V40	2000 ~	6 - cover	
C70 S70 V70	2000 ~	8 - cover	
S80	2000 ~	2 - cover	
Other Models	96 ~ 99	9 - cover	Near parking brakes

VOLKSWAGEN

Model	Year	Connector Location	Remarks
Cabrio Golf Jetta	96 ~ 99	7 - cover	
EuroVan Passat	96 ~ 99	4 - cover	
New Beetle New Cabrio New Golf New Jetta New Passat	98 ~ 00	2 - open	
Golf IV (EU)	2000 ~	8 - cover	

DISCLAIMER

All information, illustrations, and specifications contained in this user manual are based on the latest information available at the time of printing. The right is reserved to make any changes at any time without obligation to notify any person or organization of such revisions or changes.

Furthermore, the manufacturer or its sales agents are not liable for errors contained herein or for incidental or consequential damages (including lost profits) in connection with the furnishing, performance or use of this material.

This user manual tells how to use the Service Light Reset Tool to perform the required procedures on vehicles. Safe and effective use of this tool is very much dependant on the user following the normal practices and procedures outline in this manuals.

Limited Warranty

This limited warranty cover defects in materials and workmanship for a period of six (6) months which begins from the date the product is purchased by the end user and is subjected to the following terms and conditions:

1. Within the warranty period, the manufacturer will repair or replace, at their options, any defective parts and return to the owner in good working condition.
2. Any repaired or replaced parts will be warranted for the balance of the original warranty or three months (3) months from the date of repair, whichever is longer.
3. This warranty only extends to the first owner and not assignable or transferable to any subsequent owner.
4. Cost of delivery charges incurred for the repair of the product to and from the manufacturer will be borne by the owner.
5. This limited warranty covers only those defects that arises as a result of normal use and does not cover those that arises as a result of:
 - Unauthorized modifications and repair.
 - Improper operation or misuse.
 - Accident or neglect such as dropping the unit onto hard surfaces.
 - Contact with water, rain or extreme humidity.
 - Contact with extreme heat.
 - Cables that have broken, bent contact pins or subject to extreme stress or wear.

- Physical damage to the product surface including scratches, cracks or other damage to the display screen or other externally exposed parts.

Limitations of Warranty

Other than the foregoing limited warranty, the manufacturer does not make any other warranty or condition of any kind, whether express or implied.

Any implied warranty of merchantability, or fitness for use shall be limited to the duration of the foregoing limited warranty.

Otherwise, the foregoing limited warranty is the owner's sole and exclusive remedy and is in lieu of all other warranties whether express or implied.

The manufacturer or any of its exclusive sales agents shall not be liable for any consequential or incidental damages or losses arising of the loss of uses of this product.

All warranty information, product features and specifications are subjected to change without prior notice.